

## Электроды для радиохиргических аппаратов 4МГц GreenLand (China), Surgitron (USA)

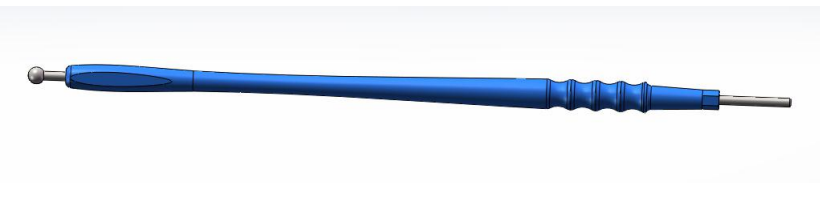

*Рабочая часть электрода - вольфрам (сплав)*

Кат. #	Изображение	Рабочая часть (mm)	Длина раб. части (mm)	Длина эл-да (mm)
B3030150R		3.0	3.0	150
B3030150H		3.0	3.0	150
B5050150R		5.0	5.0	150

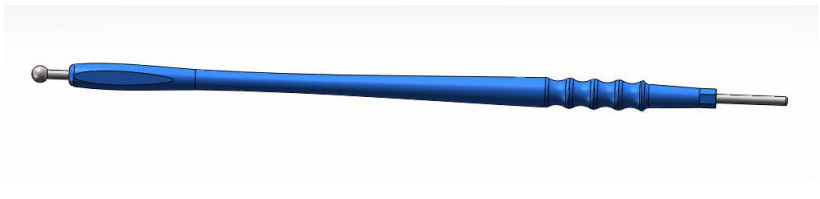
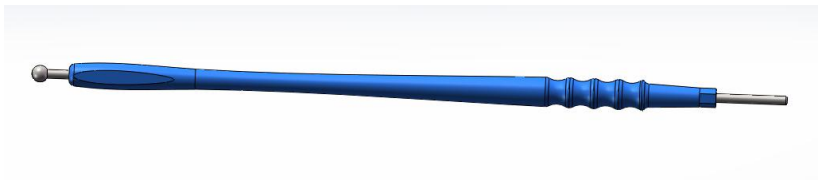

B5050150H		5.0	5.0	150
U0215150R		0.2	15	150
U0215150H		0.2	15	150
U0210150R		0.2	10	150
U0210150H		0.2	10	150

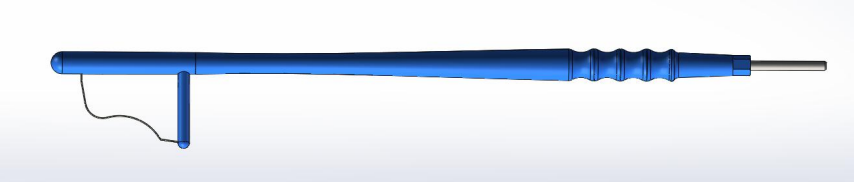
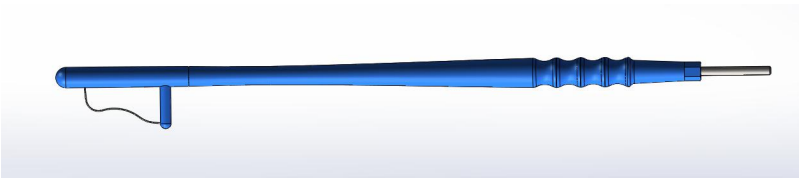
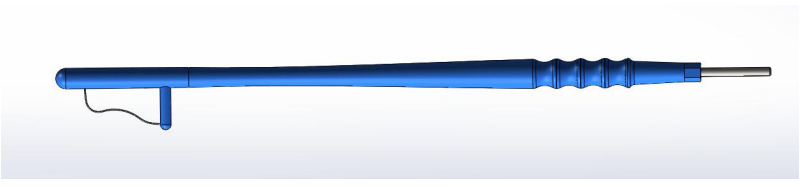
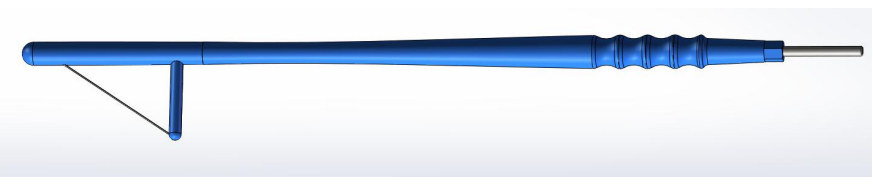
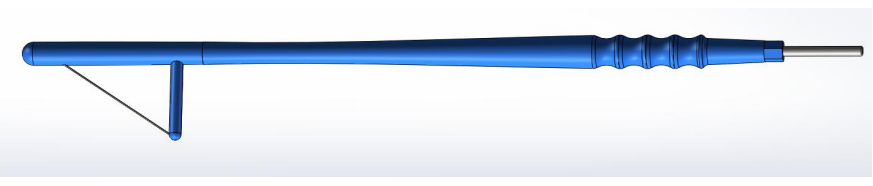

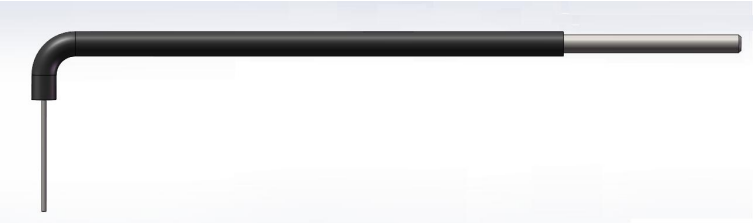

U0205150R		0.2	5	150
U0205150H		0.2	5	150
R0210150R		0.2	10	150
R0210150H		0.2	10	150
F0215150R		0.2	15	150

F0215150H		0.2	15	150
F0210150R		0.2	10	150
F0210150H		0.2	10	150
T0219150R		0.2	19	150
T0219150H		0.2	19	150







T0213150R		0.2	13	150
T0213150H		0.2	13	150
N0210040R		0.2	10	40
N0210060R		0.2	10	60
N0210080R		0.2	10	80







NO210040H		0.2	10	40
NO210060H		0.2	10	60
NO210080H		0.2	10	80
NO410040R		0.4	10	40
NO410060R		0.4	10	60





N0410080R		0.4	10	80
N0410040H		0.4	10	40
N0410060H		0.4	10	60
N0410080H		0.4	10	80
N0210040R1		0.2	10	40





N0210060R1		0.2	10	60
N0210080R1		0.2	10	80
N0210040H1		0.2	10	40
N0210060H1		0.2	10	60
N0210080H1		0.2	10	80
N0410040R1		0.4	10	40

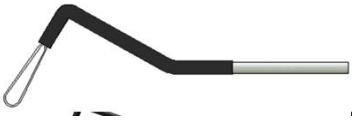

N0410060R1		0.4	10	60
N0410080R1		0.4	10	80
N0410040H1		0.4	10	40
N0410060H1		0.4	10	60
N0410080H1		0.4	10	80
T0210040R1		0.2	10	40

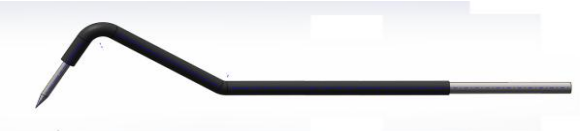

T0210060R1		0.2	10	60
T0210080R1		0.2	10	80
T0210040H1		0.2	10	40
T0210060H1		0.2	10	60
T0210080H1		0.2	10	80
L0210040R		0.2	10	40

L0210060R		0.2	10	60
L0210080R		0.2	10	80
L0210040H		0.2	10	40
L0210060H		0.2	10	60
L0210080H		0.2	10	80

C1010040R		1.0	10	40
C1010060R		1.0	10	60
C1010080R		1.0	10	80
C1010040H		1.0	10	40
C1010060H		1.0	10	60
C1010080H		1.0	10	80





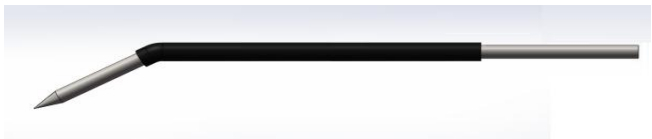



B2525040R		2.5	2.5	40
B2525060R		2.5	2.5	60
B2525080R		2.5	2.5	80
B3535040R		3.5	3.5	40
B3535060R		3.5	3.5	60







B3535080R		3.5	3.5	80
B3535040H		3.5	3.5	40
B3535060H		3.5	3.5	60
B3535080H		3.5	3.5	80
C1612040R1		1.6	12	40





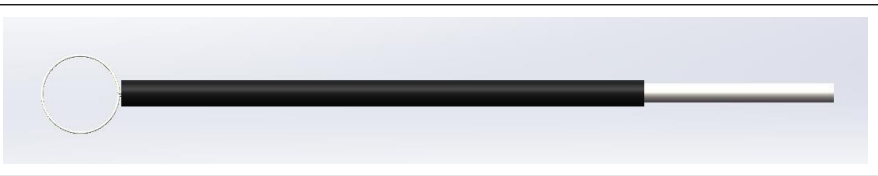
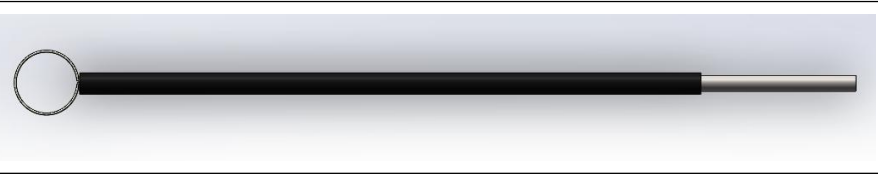



C1612060R1		1.6	12	60
C1612080R1		1.6	12	80
C1612040H1		1.6	12	40
C1612060H1		1.6	12	60
C1612080H1		1.6	12	80









N0208040R		0.2	8	40
N0208060R		0.2	8	60
N0208080R		0.2	8	80
N0208040H		0.2	8	40
N0208060H		0.2	8	60
N0208080H		0.2	8	80





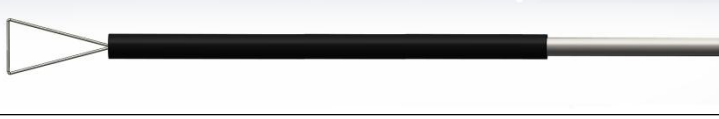



C1612040R		1.6	12	40
C1612060R		1.6	12	60
C1612080R		1.6	12	80
C1612040H		1.6	12	40
C1612060H		1.6	12	60
C1612080H		1.6	12	80
L0207040R		0.2	7	40
L0207060R		0.2	7	60

L0207080R		0.2	7	80
L0207040H		0.2	7	40
L0207060H		0.2	7	60
L0207080H		0.2	7	80
D0210040R		0.2	10	40
D0210060R		0.2	10	60
D0210080R		0.2	10	80
D0210040H		0.2	10	40

D0210060H		0.2	10	60
D0210080H		0.2	10	80
N0207040R		0.2	7	40
N0207060R		0.2	7	60
N0207080R		0.2	7	80
N0207040H		0.2	7	40
N0207060H		0.2	7	60
N0207080H		0.2	7	80
T0210040R		0.2	10	40

T0210060R		0.2	10	60
T0210080R		0.2	10	80
T0210040H		0.2	10	40
T0210060H		0.2	10	60
T0210080H		0.2	10	80
B3535040R		3.5	3.5	40
B3535060R		3.5	3.5	60
B3535080R		3.5	3.5	80

B3535040H		3.5	3.5	40
B3535060H		3.5	3.5	60
B3535080H		3.5	3.5	80
K0220070H1		0.2	20	70
K0220070H		0.2	20	70
N0503115R		0.5	3	115